

1.

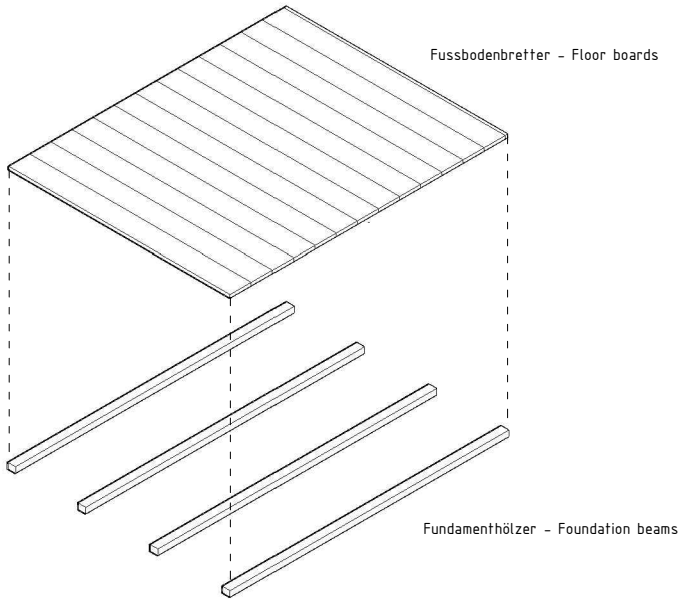

2.

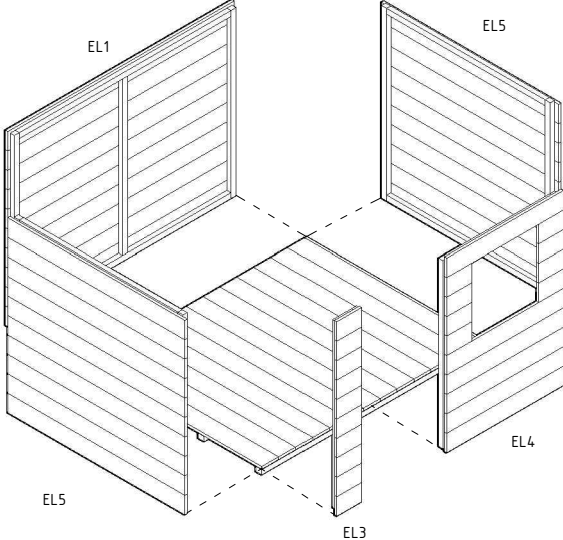

3.

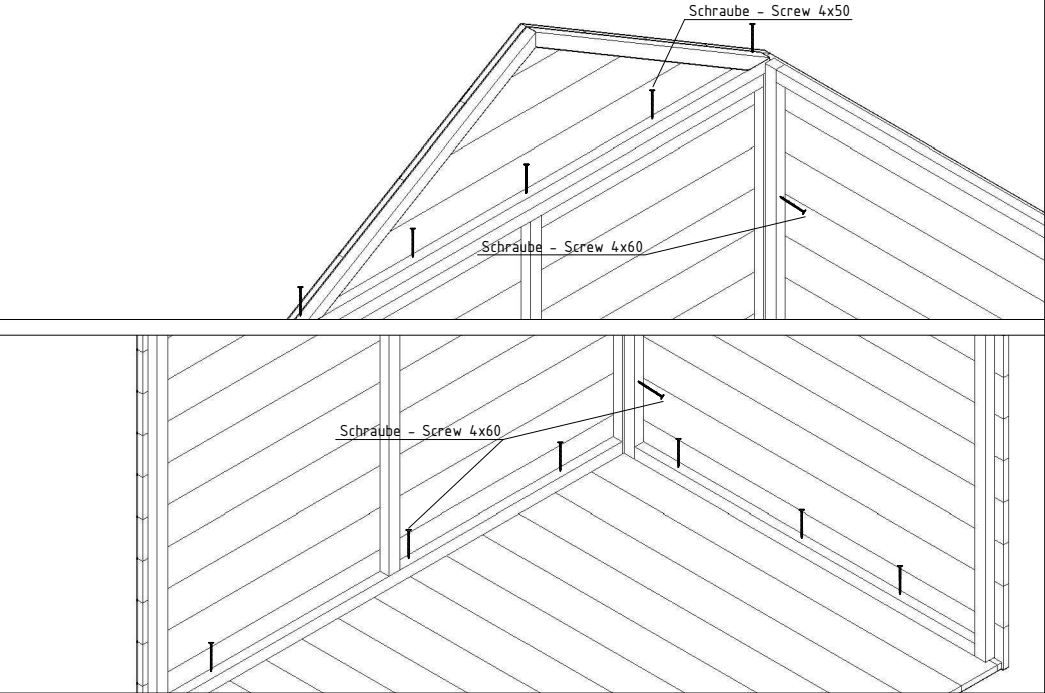
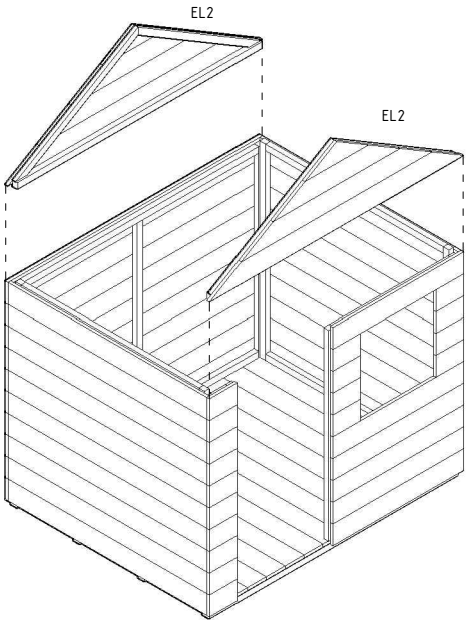

4.

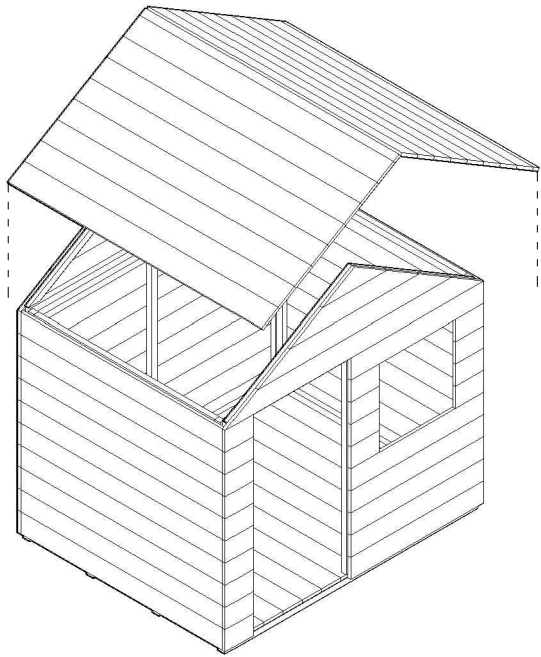

5.

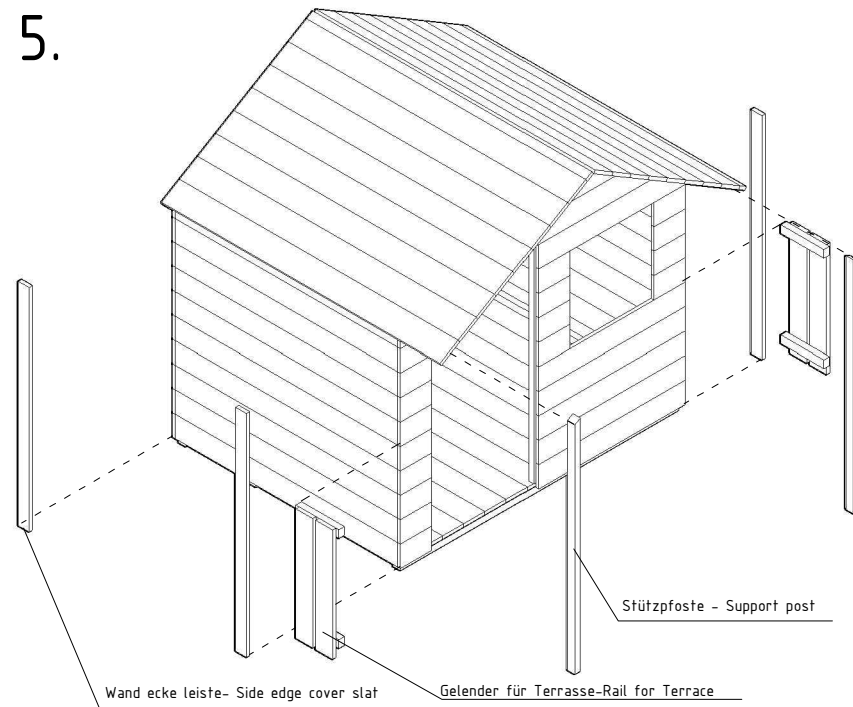

6.

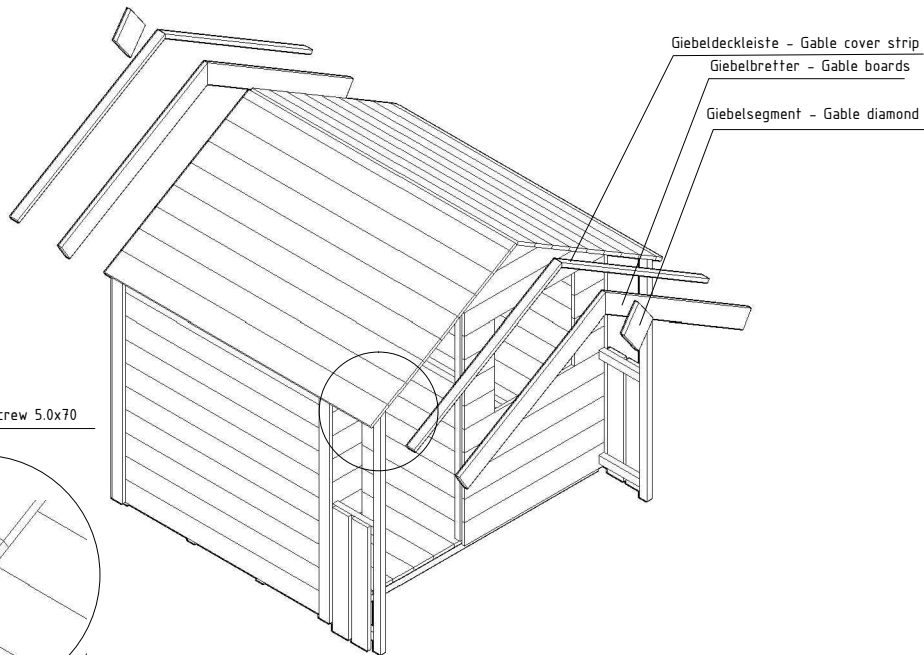

Schraube - Screw 5.0x70

7.

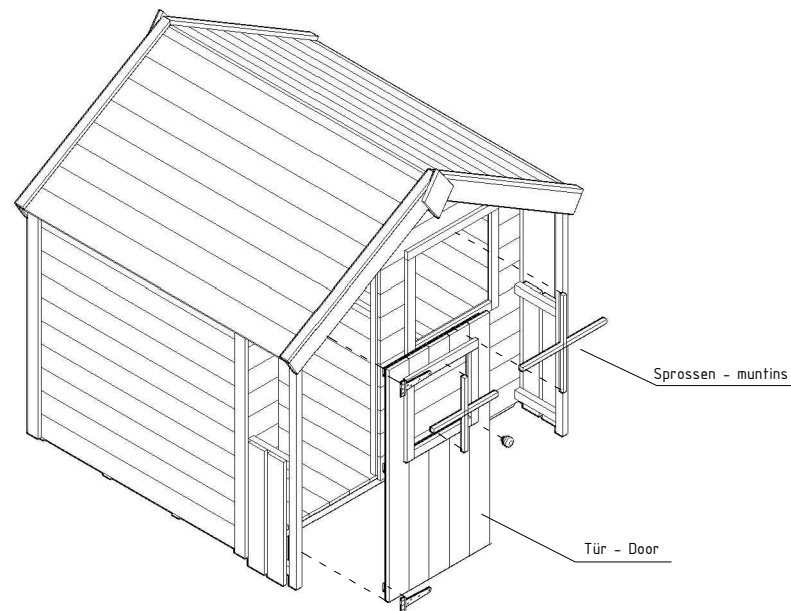

Wand / Wall 1

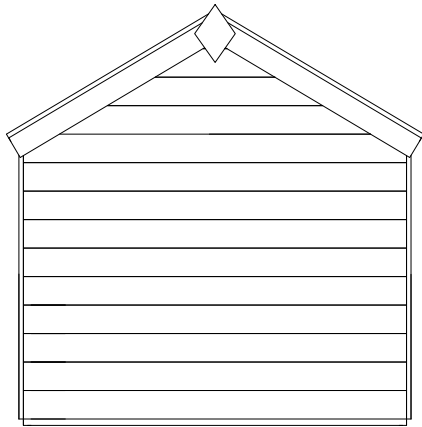

Wand / Wall 2

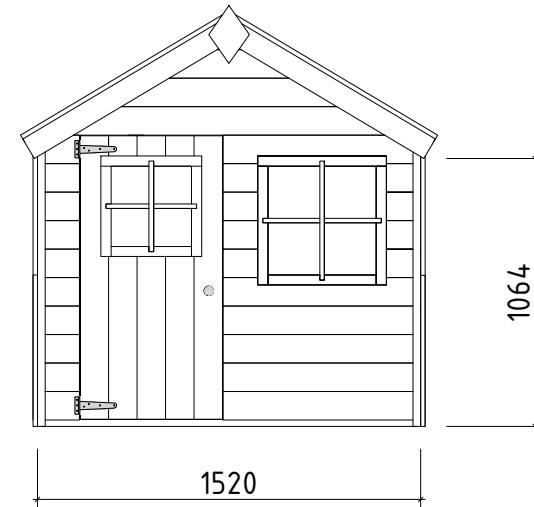

Wand / Wall A

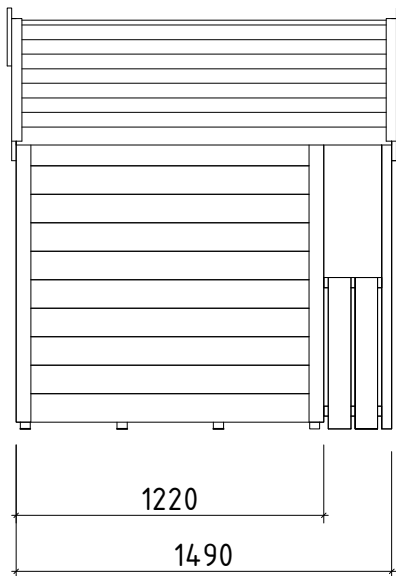

Wand / Wall B

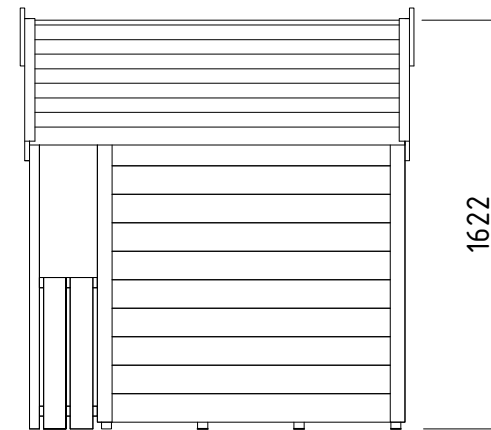

Name	Sneeuwitje 152x122_16		
Zeichnung/Drawing	WAND/WALL		
Profil/Profile	1.6x11.3	Datum/Date	15.12.2016

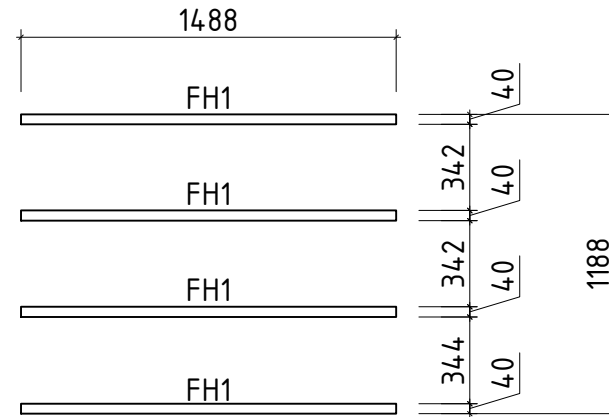
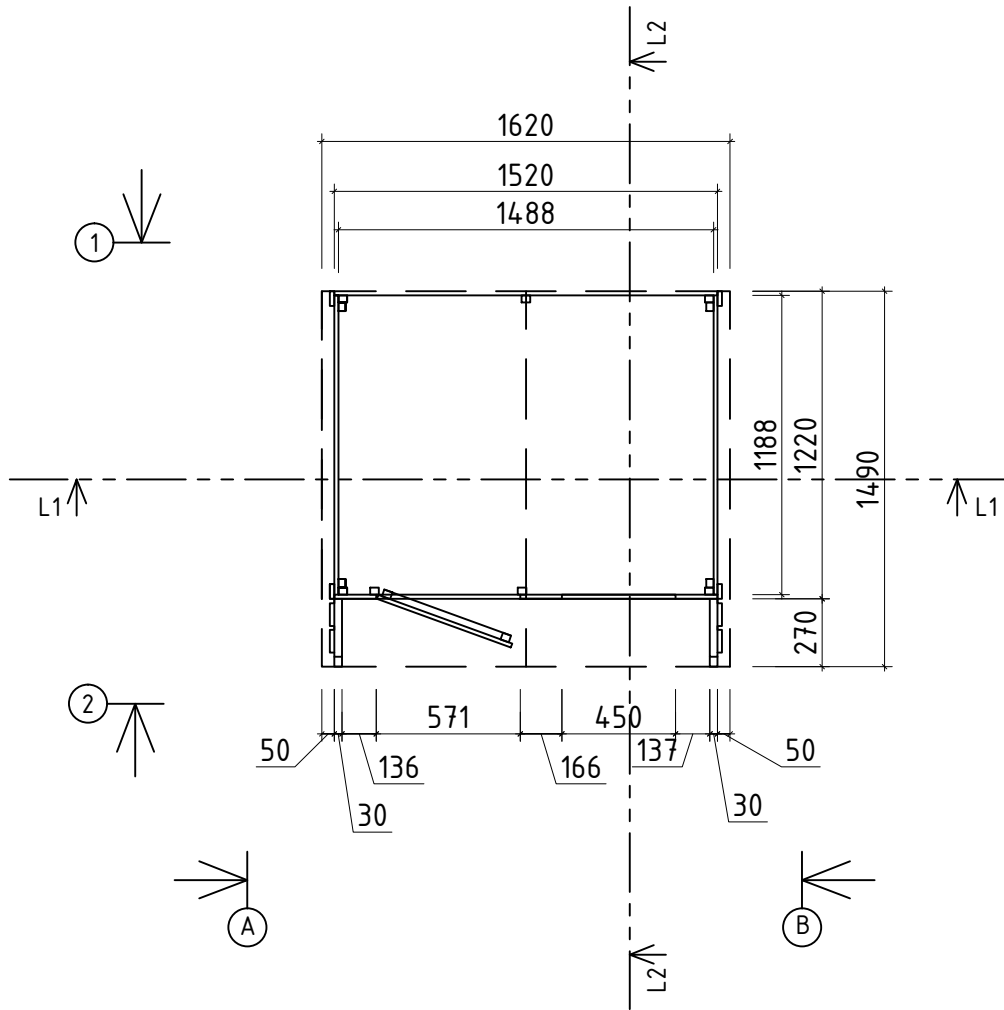

Name	Sneeuwitje 152x122_16	
Zeichnung/Drawing	Grundplan/Plan, Lagerholzplan/Foundation beams	
Profil/Profile	1.6x11.3	Datum/Date 15.12.2016

L1-L1

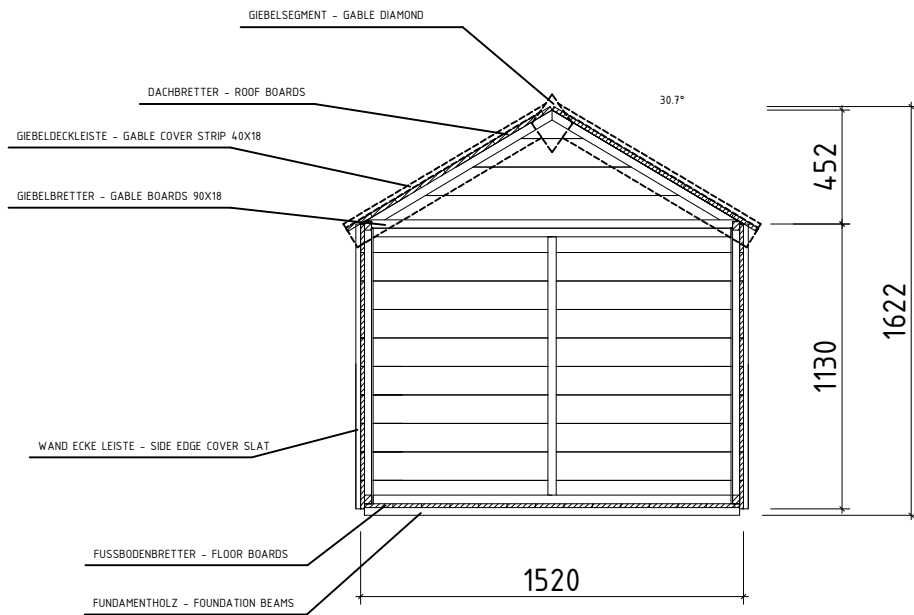

L2-L2

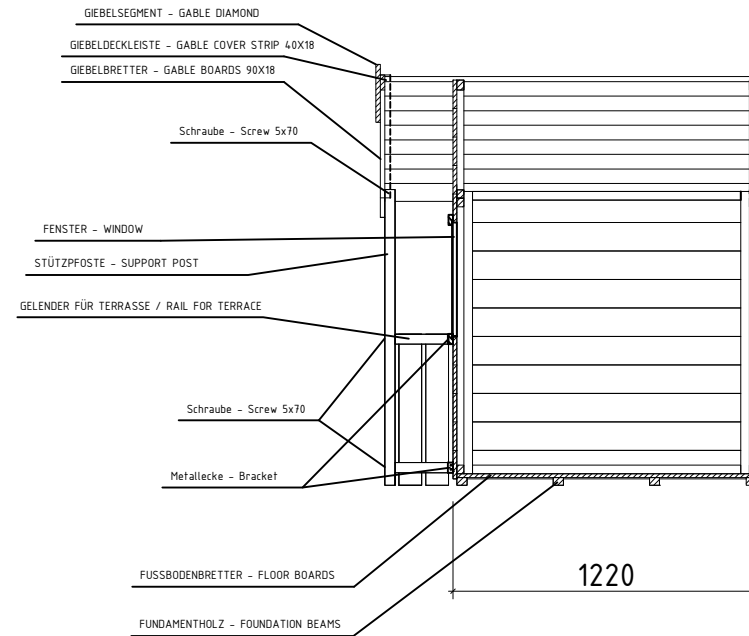

Name	Sneeuwitje 152x122_16		
Zeichnung/Drawing	Schnitt/Section		
Profil/Profile	1.6x11.3	Datum/Date	15.12.2016

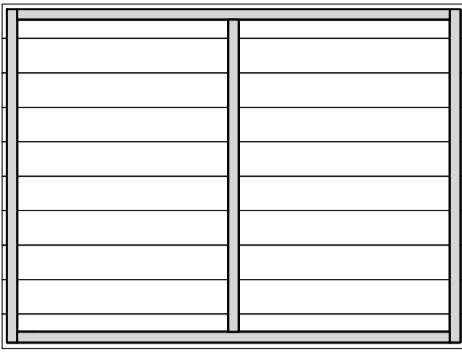
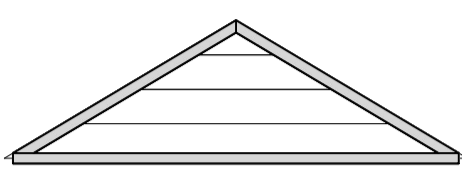
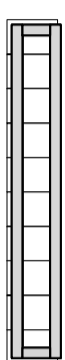
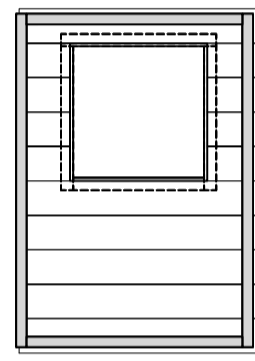
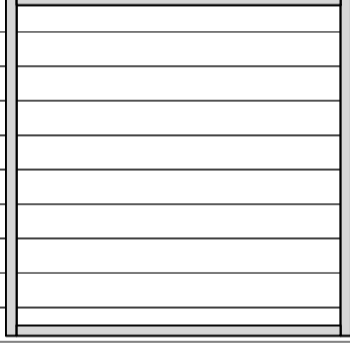
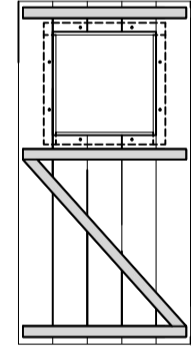
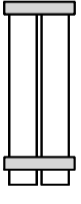
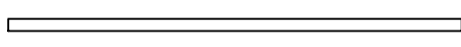
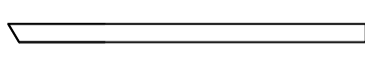
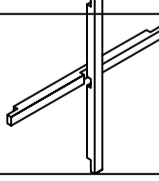
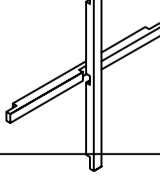
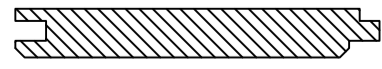
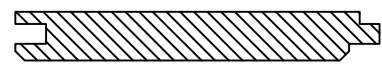
Pos	Teileliste/Specification Sneeuwitje 152x122_16		Stck. Pcs.	Profil Profile (mm)	Länge Length (mm)
EL1	Wand / Wall 1		1	1520x1130	
EL2	Wand / Wall 1 Wand / Wall 2		2	1520x469	
EL3	Wand / Wall 2		1	176x1130	
EL4	Wand / Wall 2 mit Fenster / with Window		1	793x1130	
EL5	Wand / Wall 3 Wand / Wall 4		2	1188x1140	
EL6	Tür / Door 565x1125		1	565x1125	
EL7	Gelender für Terrasse / Rail for Terrace		2	230x600	
FH1	FUNDAMENTHOLZ (imprägniert) - FOUNDATION BEAM (impregnated)		4	30x40	1488
LE4	Wand ecke leiste - Side edge cover slat		4	58x18	1130
LE2	Stützpfoste - Support post		2	40x30	1174
Sprossen - Muntins	Fenster - Window		2+2	18x18	470
Sprossen - Muntins	Tür Fenster - Door Window		2+2	18x18	359
DACHBRETTER - ROOF BOARDS			18	113x16	1490
FUSSBODENBRETTER - FLOOR BOARDS			14	113x16	1185
Kood	Sneeuwitje 152x122_16	Materjal	File	Sneeuwitje 152x122_16 KL	ENTwurf 1/2

